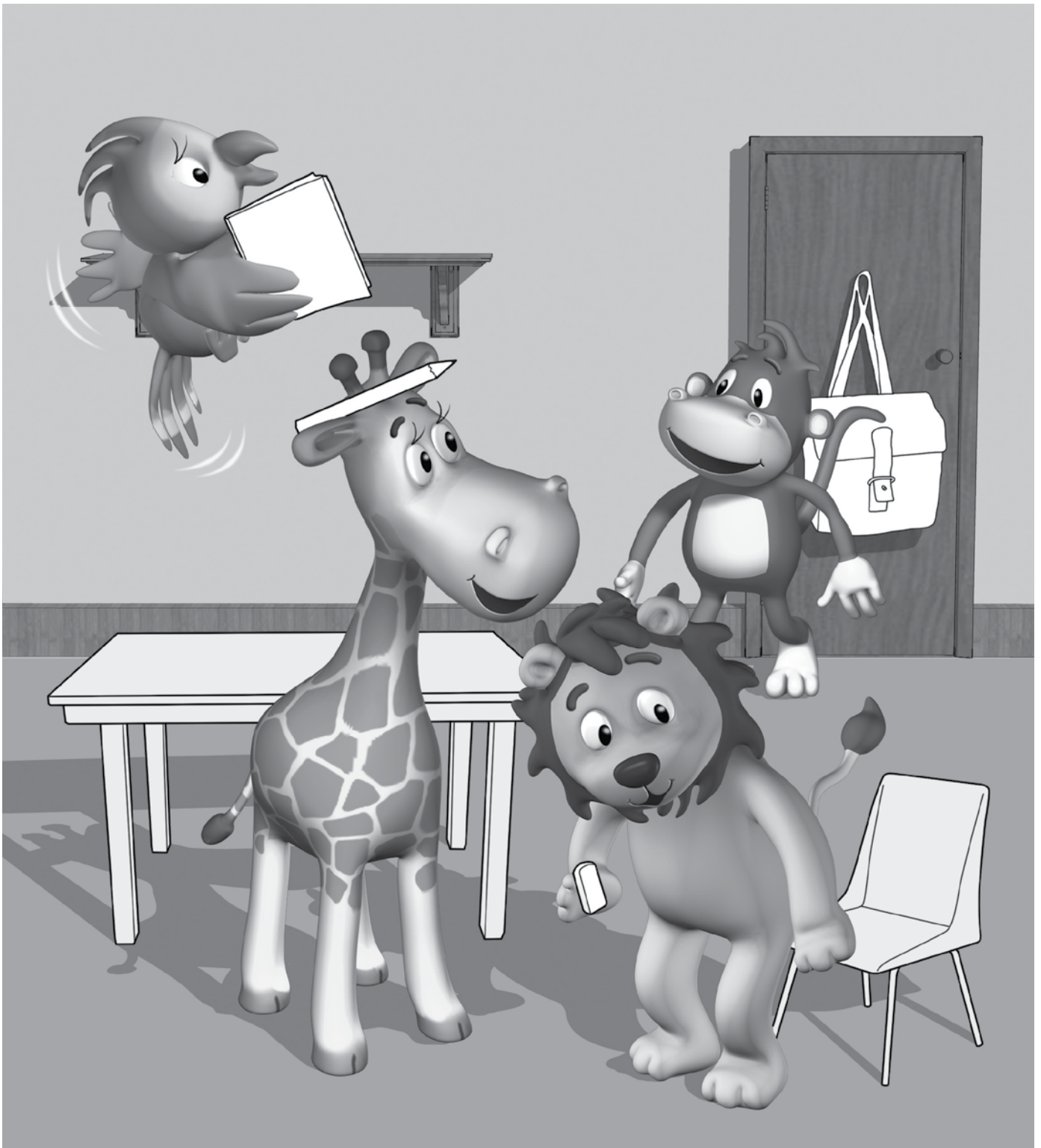

## 1

# My classroom

1

**Find and colour.**

8

**pencil, chair, bag, rubber, book, desk**

1 CD1 14 Listen and circle.

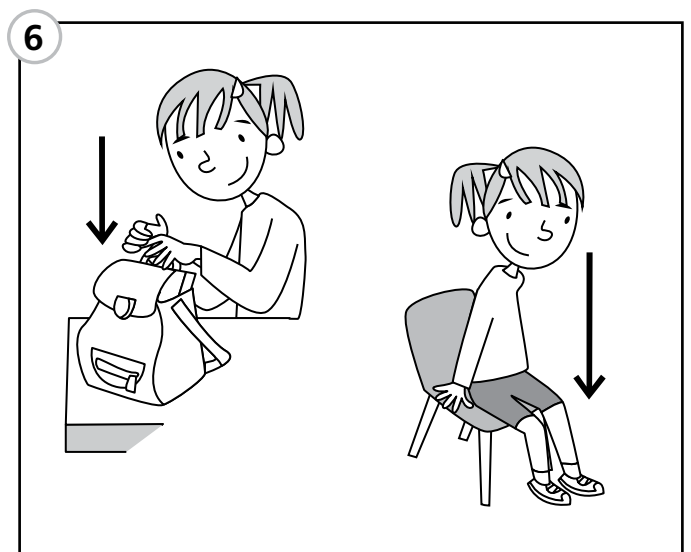
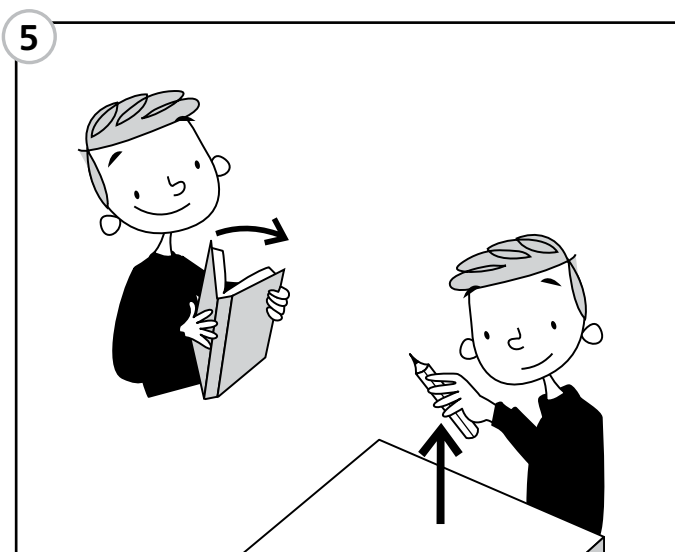
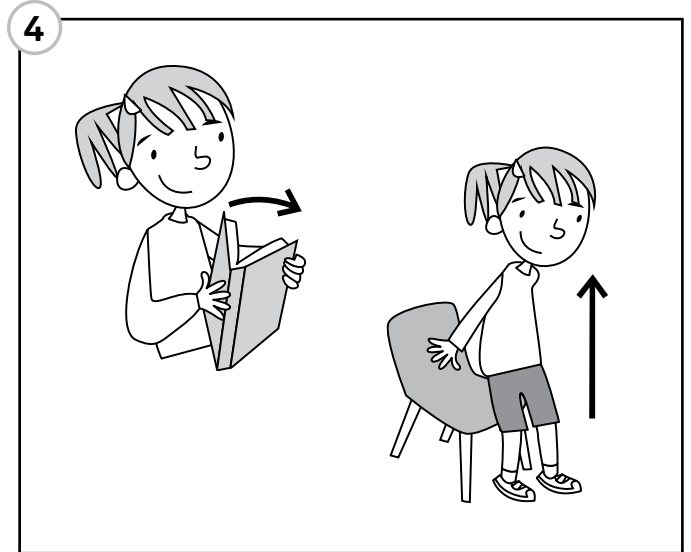
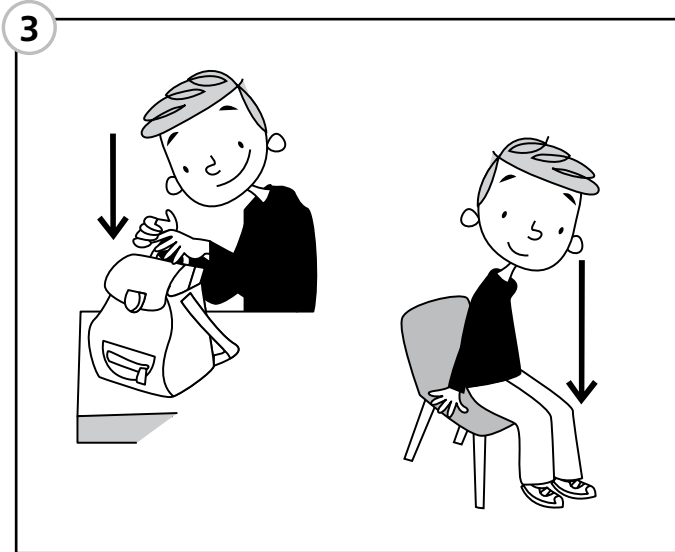
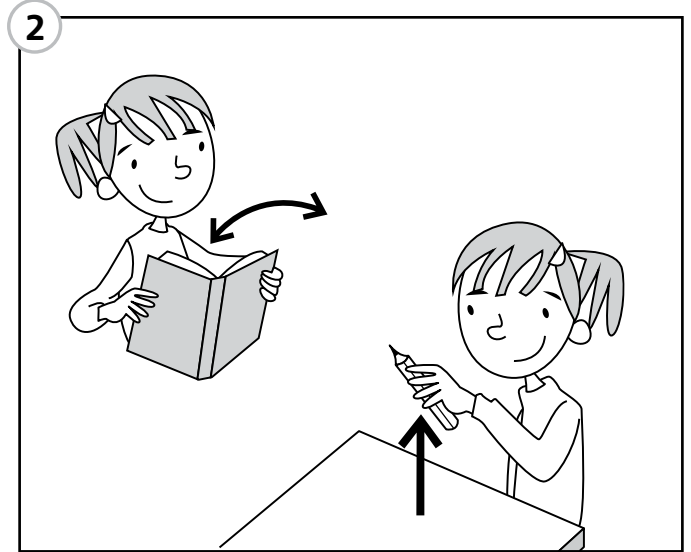
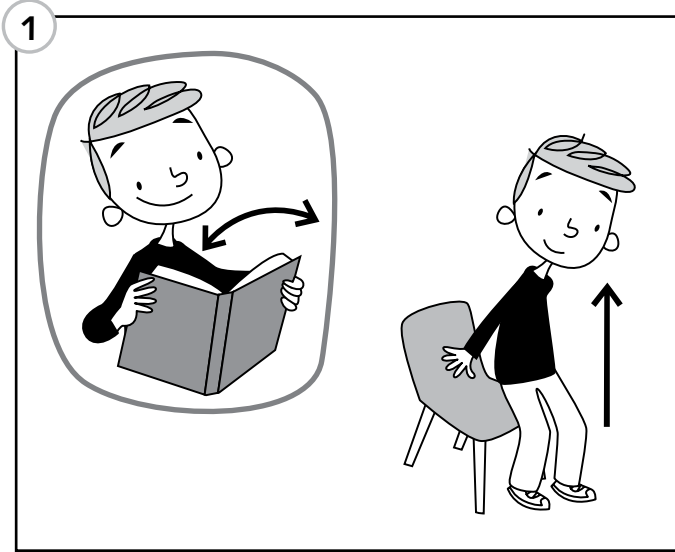

Stand up. Sit down. Open ... Close ... Pick up ... Put ... 9

**1** Draw and colour.

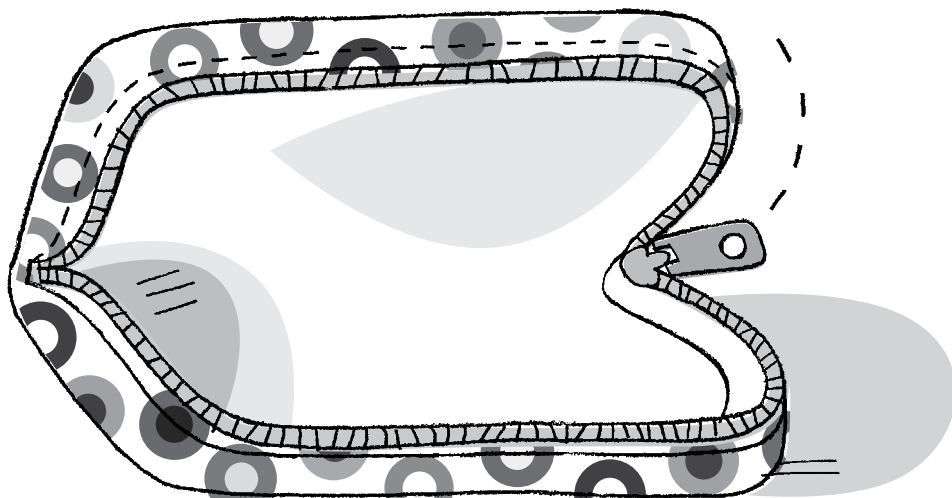
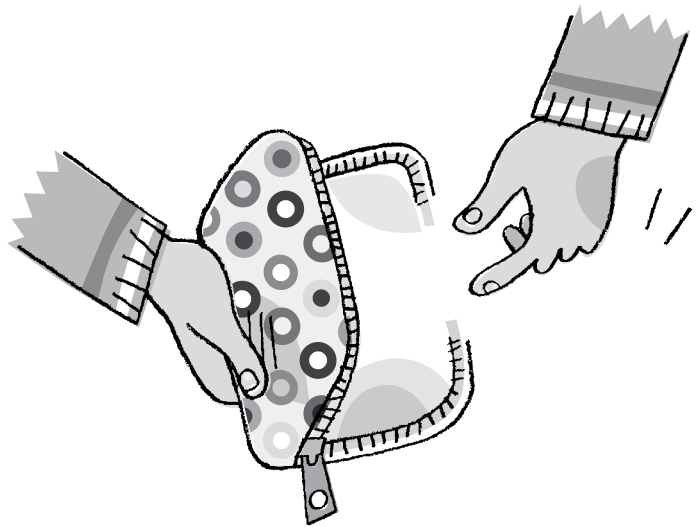
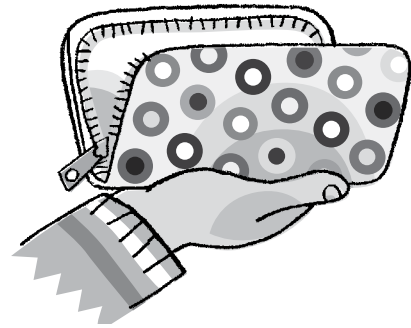
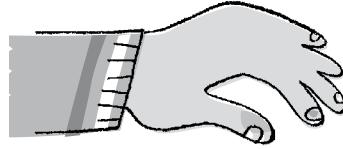

1

1 Think! Count and match.

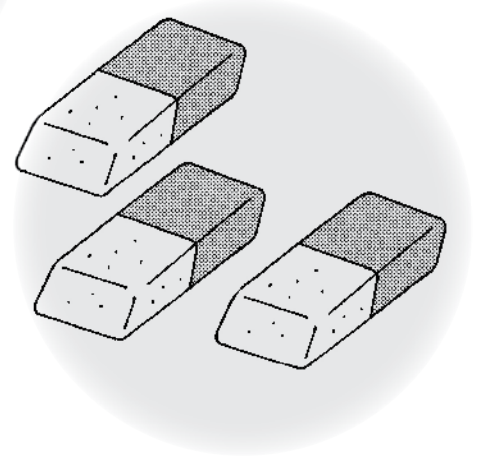
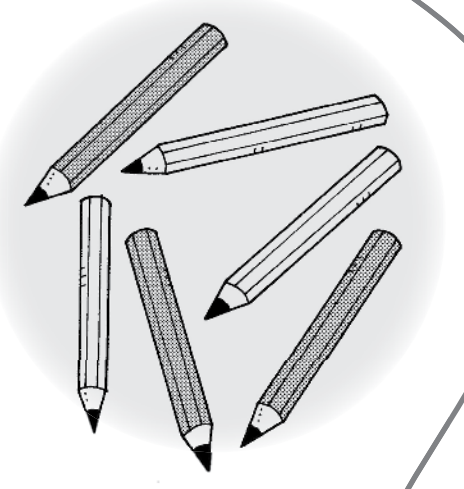
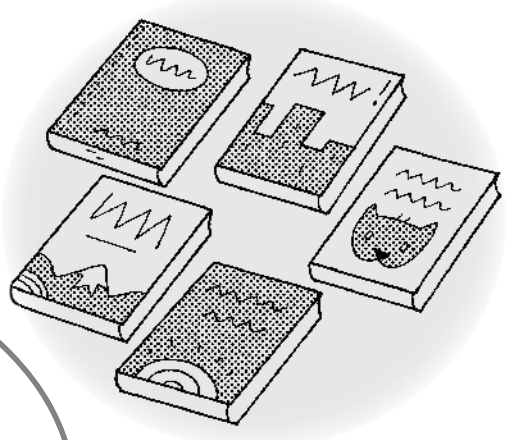
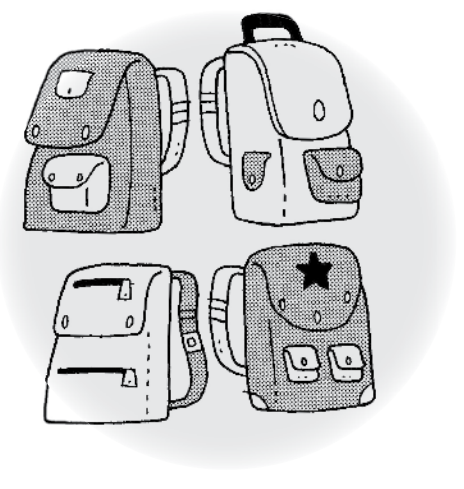
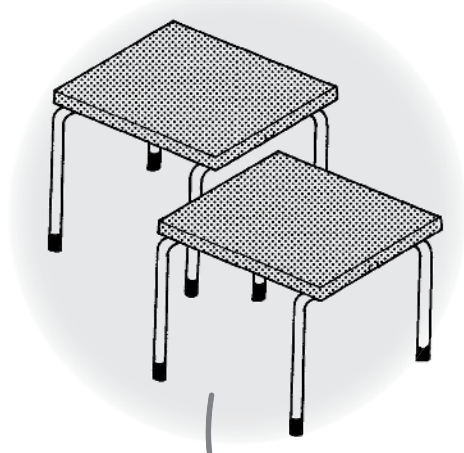

1 2 3 4 5 6

one, two, three, four, five, six 11

**1**  **Listen and trace.**

1



2



3



4



**12** Story practice



1 **Think!** Look and colour.

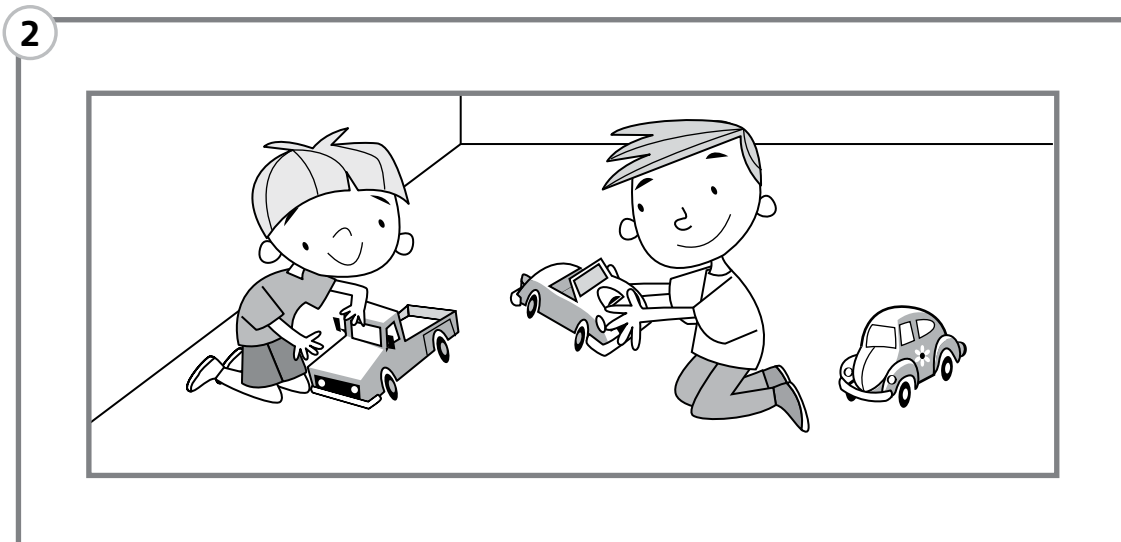
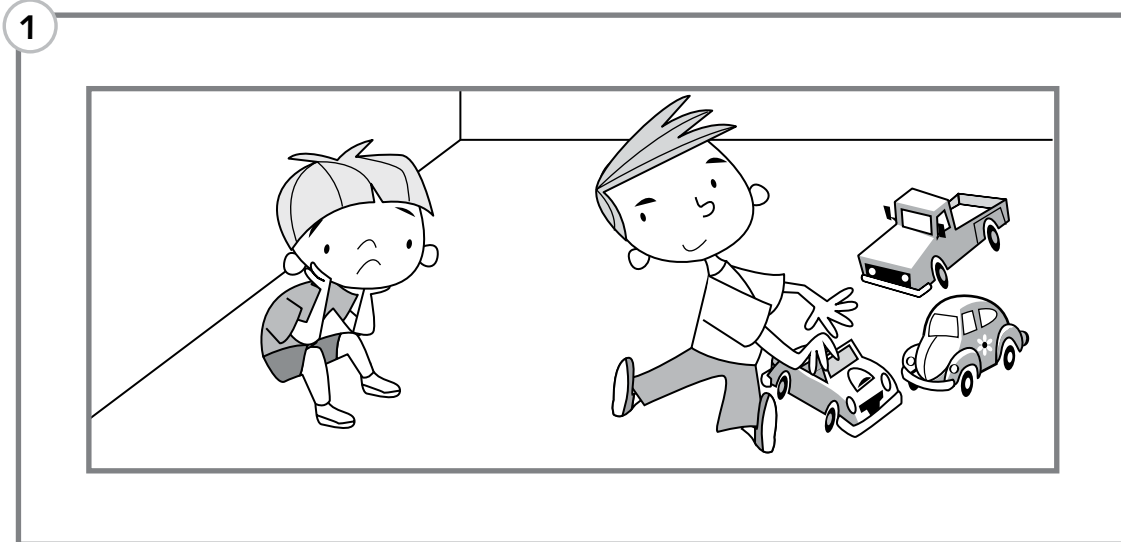

**1** CD1  
21 Listen and colour. Colour to match.

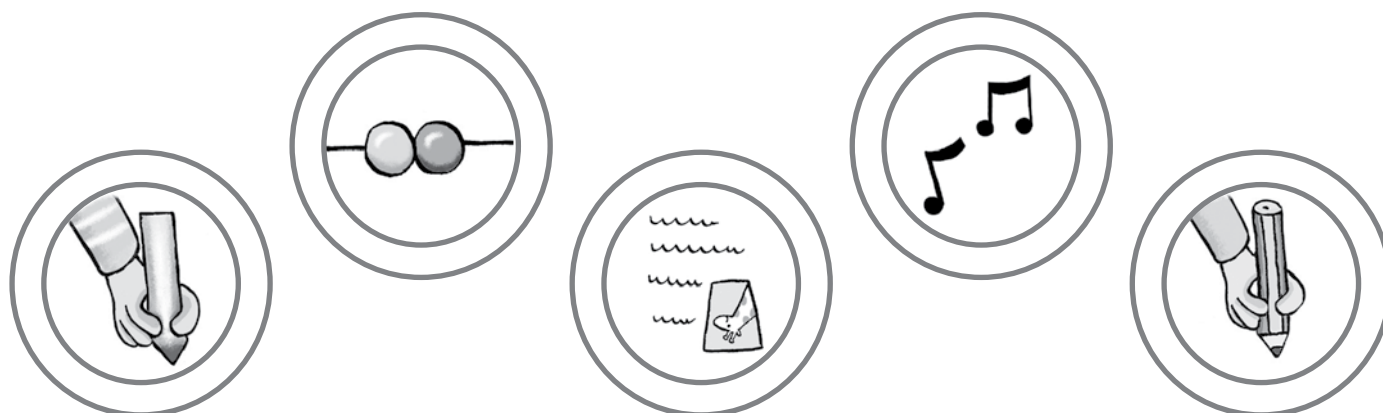
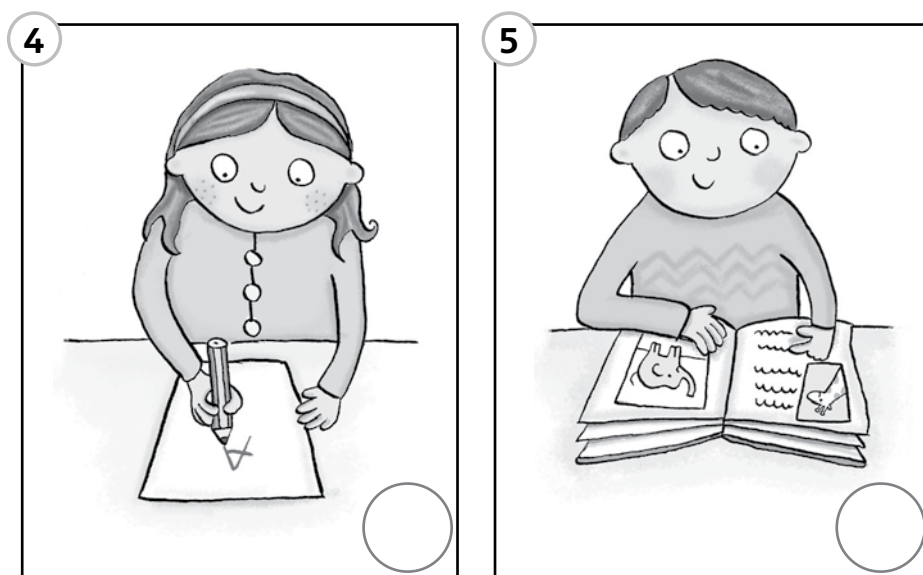

1 Look and circle.

1



2

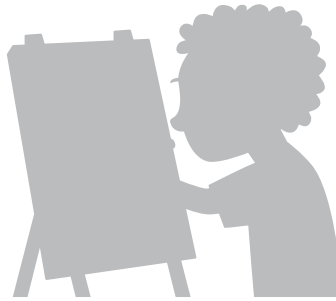
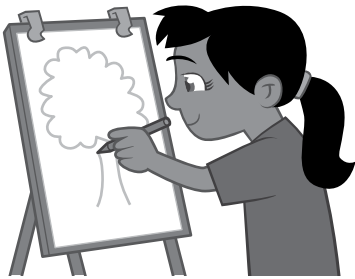

3



4



5

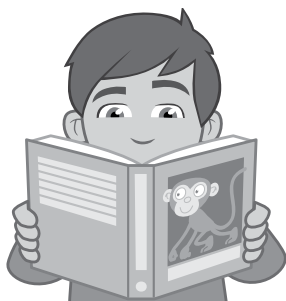





1 Say the words. Colour the circles.

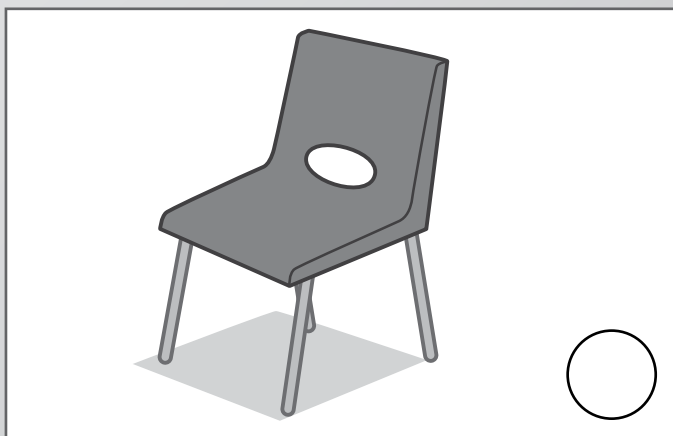
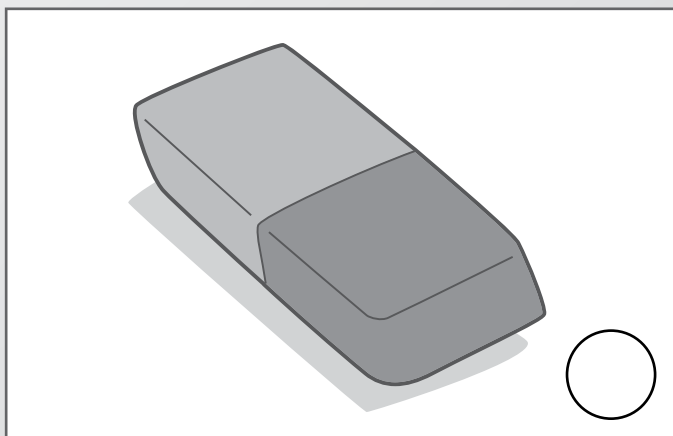
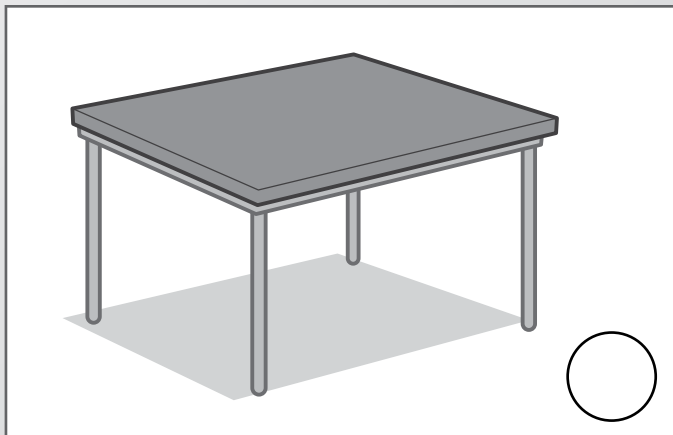
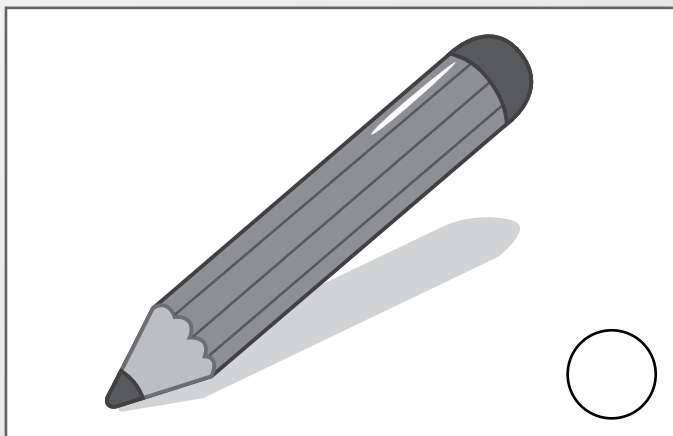

2 Draw faces. 😊 😐 ☹️

